

## Infrared Emitting Diode, 950 nm, GaAs

### Description

TSUS540. series are infrared emitting diodes in standard GaAs on GaAs technology, molded in a clear, blue-grey tinted plastic package. The devices are spectrally matched to silicon photodiodes and phototransistors.

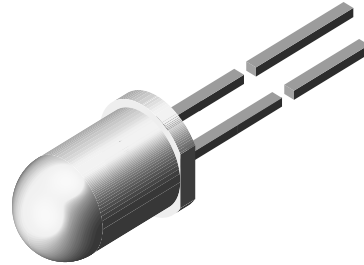

94 8389

### Features

- Low cost emitter
- Low forward voltage
- High radiant power and radiant intensity
- Suitable for DC and high pulse current operation
- Standard T-1 $\frac{3}{4}$  ( $\varnothing$  5 mm) package
- Comfortable angle of half intensity  $\varphi = \pm 22^\circ$
- Peak wavelength  $\lambda_p = 950$  nm
- High reliability
- Good spectral matching to Si photodetectors
- Lead-free component
- Component in accordance to RoHS 2002/95/EC and WEEE 2002/96/EC

### Applications

Infrared remote control and free air transmission systems with low forward voltage and comfortable radiation angle requirements in combination with PIN photodiodes or phototransistors.

### Absolute Maximum Ratings

$T_{amb} = 25^\circ\text{C}$ , unless otherwise specified

Parameter	Test condition	Symbol	Value	Unit
Reverse Voltage		$V_R$	5	V
Forward current		$I_F$	150	mA
Peak Forward Current	$t_p/T = 0.5$ , $t_p = 100 \mu\text{s}$	$I_{FM}$	300	mA
Surge Forward Current	$t_p = 100 \mu\text{s}$	$I_{FSM}$	2.5	A
Power Dissipation		$P_V$	210	mW
Junction Temperature		$T_j$	100	$^\circ\text{C}$
Operating Temperature Range		$T_{amb}$	- 55 to + 100	$^\circ\text{C}$
Storage Temperature Range		$T_{stg}$	- 55 to + 100	$^\circ\text{C}$
Soldering Temperature	$t \leq 5$ sec, 2 mm from case	$T_{sd}$	260	$^\circ\text{C}$
Thermal Resistance Junction/Ambient		$R_{thJA}$	375	K/W

### Electrical Characteristics

$T_{amb} = 25\text{ }^{\circ}\text{C}$ , unless otherwise specified

Parameter	Test condition	Symbol	Min	Typ.	Max	Unit
Forward Voltage	$I_F = 100\text{ mA}$ , $t_p = 20\text{ ms}$	$V_F$		1.3	1.7	V
Temp. Coefficient of $V_F$	$I_F = 100\text{ mA}$	$TK_{V_F}$		- 1.3		mV/K
Reverse Current	$V_R = 5\text{ V}$	$I_R$			100	$\mu\text{A}$
Junction capacitance	$V_R = 0\text{ V}$ , $f = 1\text{ MHz}$ , $E = 0$	$C_j$		30		pF

### Optical Characteristics

$T_{amb} = 25\text{ }^{\circ}\text{C}$ , unless otherwise specified

Parameter	Test condition	Symbol	Min	Typ.	Max	Unit
Temp. Coefficient of $\phi_e$	$I_F = 20\text{ mA}$	$TK\phi_e$		- 0.8		%/K
Angle of Half Intensity		$\phi$		$\pm 22$		deg
Peak Wavelength	$I_F = 100\text{ mA}$	$\lambda_p$		950		nm
Spectral Bandwidth	$I_F = 100\text{ mA}$	$\Delta\lambda$		50		nm
Temp. Coefficient of $\lambda_p$	$I_F = 100\text{ mA}$	$TK\lambda_p$		0.2		nm/K
Rise Time	$I_F = 100\text{ mA}$	$t_r$		800		ns
	$I_F = 1.5\text{ A}$	$t_r$		400		ns
Fall Time	$I_F = 100\text{ mA}$	$t_f$		800		ns
	$I_F = 1.5\text{ A}$	$t_f$		400		ns
Virtual Source Diameter		$\emptyset$		2.9		mm

### Type Dedicated Characteristics

$T_{amb} = 25\text{ }^{\circ}\text{C}$ , unless otherwise specified

Parameter	Test condition	Part	Symbol	Min	Typ.	Max	Unit
Forward Voltage	$I_F = 1.5\text{ A}$ , $t_p = 100\text{ }\mu\text{s}$	TSUS5400	$V_F$		2.2	3.4	V
		TSUS5401	$V_F$		2.2	3.4	V
		TSUS5402	$V_F$		2.2	2.7	V
Radiant Intensity	$I_F = 100\text{ mA}$ , $t_p = 20\text{ ms}$	TSUS5400	$I_e$	7	14	35	mW/sr
		TSUS5401	$I_e$	10	17	35	mW/sr
		TSUS5402	$I_e$	15	20	35	mW/sr
	$I_F = 1.5\text{ A}$ , $t_p = 100\text{ }\mu\text{s}$	TSUS5400	$I_e$	60	140		mW/sr
		TSUS5401	$I_e$	85	160		mW/sr
		TSUS5402	$I_e$	120	190		mW/sr
Radiant Power	$I_F = 100\text{ mA}$ , $t_p = 20\text{ ms}$	TSUS5400	$\phi_e$		13		mW
		TSUS5401	$\phi_e$		14		mW
		TSUS5402	$\phi_e$		15		mW

## Typical Characteristics ( $T_{amb} = 25\text{ }^{\circ}\text{C}$ unless otherwise specified)

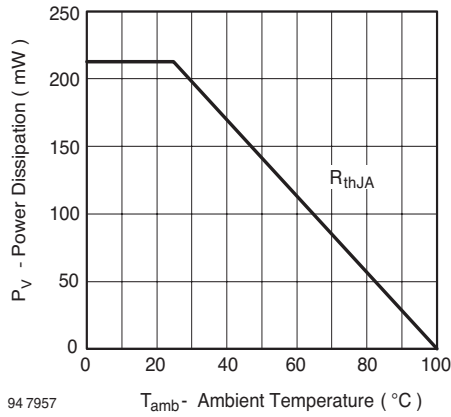

Figure 1. Power Dissipation vs. Ambient Temperature

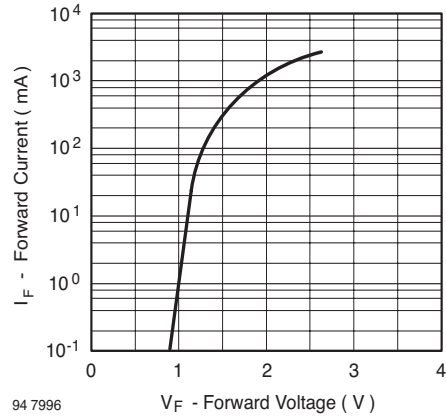

Figure 4. Forward Current vs. Forward Voltage

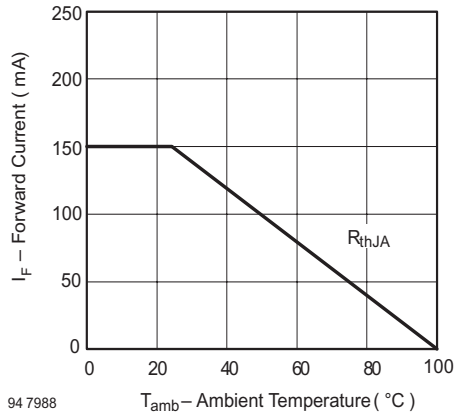

Figure 2. Forward Current vs. Ambient Temperature

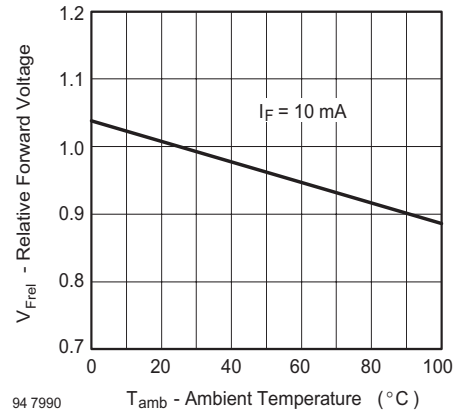

Figure 5. Relative Forward Voltage vs. Ambient Temperature

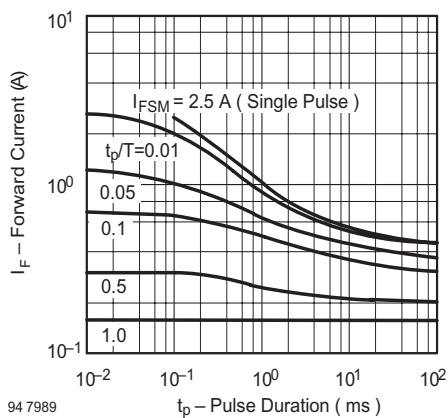

Figure 3. Pulse Forward Current vs. Pulse Duration

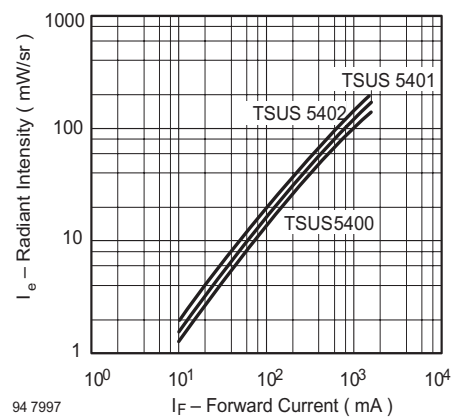

Figure 6. Radiant Intensity vs. Forward Current

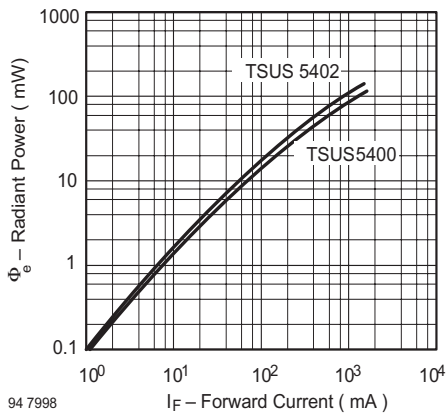

Figure 7. Radiant Power vs. Forward Current

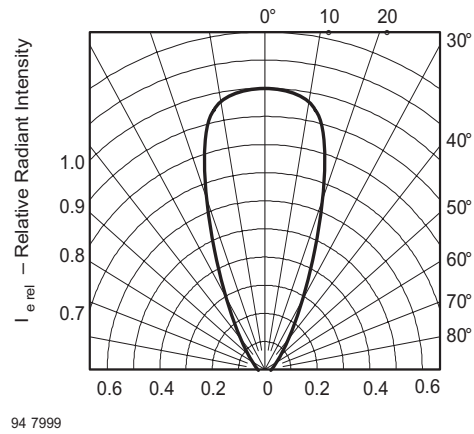

Figure 10. Relative Radiant Intensity vs. Angular Displacement

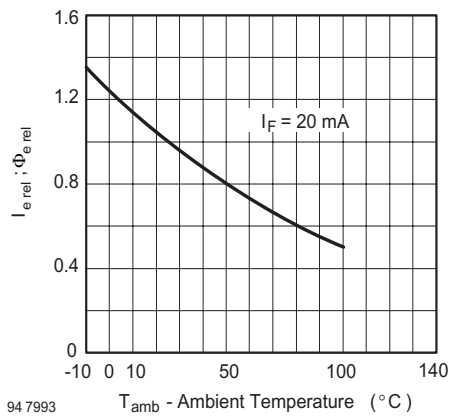

Figure 8. Rel. Radiant Intensity/Power vs. Ambient Temperature

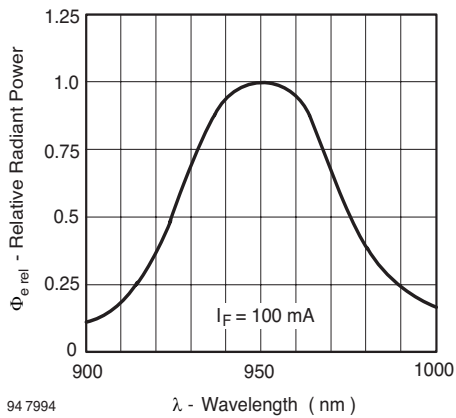
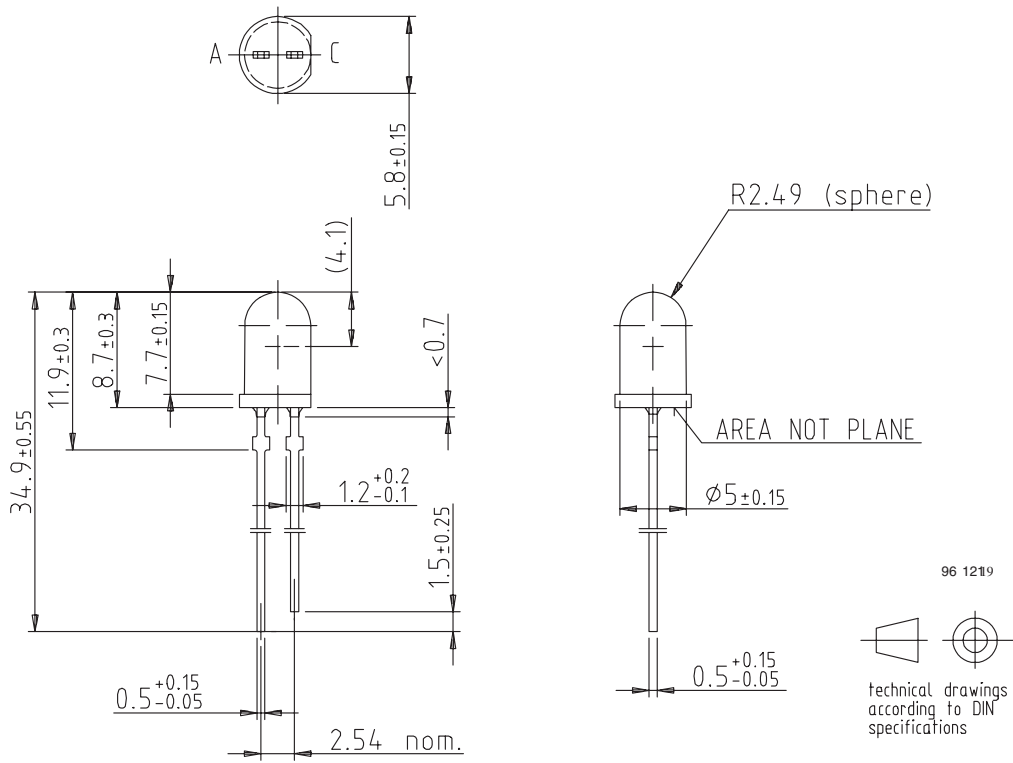

Figure 9. Relative Radiant Power vs. Wavelength

## Package Dimensions in mm



### Ozone Depleting Substances Policy Statement

It is the policy of Vishay Semiconductor GmbH to

1. Meet all present and future national and international statutory requirements.
2. Regularly and continuously improve the performance of our products, processes, distribution and operating systems with respect to their impact on the health and safety of our employees and the public, as well as their impact on the environment.

It is particular concern to control or eliminate releases of those substances into the atmosphere which are known as ozone depleting substances (ODSs).

The Montreal Protocol (1987) and its London Amendments (1990) intend to severely restrict the use of ODSs and forbid their use within the next ten years. Various national and international initiatives are pressing for an earlier ban on these substances.

Vishay Semiconductor GmbH has been able to use its policy of continuous improvements to eliminate the use of ODSs listed in the following documents.

1. Annex A, B and list of transitional substances of the Montreal Protocol and the London Amendments respectively
2. Class I and II ozone depleting substances in the Clean Air Act Amendments of 1990 by the Environmental Protection Agency (EPA) in the USA
3. Council Decision 88/540/EEC and 91/690/EEC Annex A, B and C (transitional substances) respectively.

Vishay Semiconductor GmbH can certify that our semiconductors are not manufactured with ozone depleting substances and do not contain such substances.

We reserve the right to make changes to improve technical design  
and may do so without further notice.

Parameters can vary in different applications. All operating parameters must be validated for each customer application by the customer. Should the buyer use Vishay Semiconductors products for any unintended or unauthorized application, the buyer shall indemnify Vishay Semiconductors against all claims, costs, damages, and expenses, arising out of, directly or indirectly, any claim of personal damage, injury or death associated with such unintended or unauthorized use.

Vishay Semiconductor GmbH, P.O.B. 3535, D-74025 Heilbronn, Germany  
Telephone: 49 (0)7131 67 2831, Fax number: 49 (0)7131 67 2423