

- Designed for Complementary Use with the BD250 Series
- 125 W at 25°C Case Temperature
- 25 A Continuous Collector Current
- 40 A Peak Collector Current
- Customer-Specified Selections Available

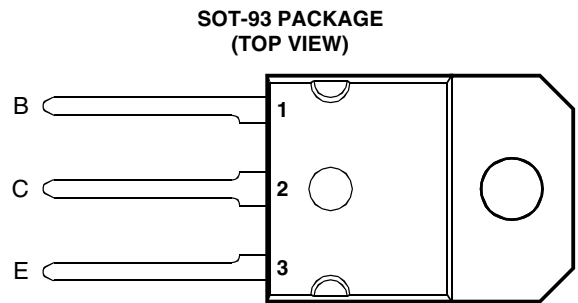

Pin 2 is in electrical contact with the mounting base.

MDTRAAA

absolute maximum ratings at 25°C case temperature (unless otherwise noted)

RATING		SYMBOL	VALUE	UNIT
Collector-emitter voltage ($R_{BE} = 100 \Omega$)	BD249	V_{CER}	55	V
	BD249A		70	
	BD249B		90	
	BD249C		115	
Collector-emitter voltage ($I_C = 30 \text{ mA}$)	BD249	V_{CEO}	45	V
	BD249A		60	
	BD249B		80	
	BD249C		100	
Emitter-base voltage		V_{EBO}	5	V
Continuous collector current		I_C	25	A
Peak collector current (see Note 1)		I_{CM}	40	A
Continuous base current		I_B	5	A
Continuous device dissipation at (or below) 25°C case temperature (see Note 2)		P_{tot}	125	W
Continuous device dissipation at (or below) 25°C free air temperature (see Note 3)		P_{tot}	3	W
Unclamped inductive load energy (see Note 4)		$\frac{1}{2}LI_C^2$	90	mJ
Operating junction temperature range		T_j	-65 to +150	°C
Storage temperature range		T_{stg}	-65 to +150	°C
Lead temperature 3.2 mm from case for 10 seconds		T_L	250	°C

- NOTES: 1. This value applies for $t_p \leq 0.3 \text{ ms}$, duty cycle $\leq 10\%$.
 2. Derate linearly to 150°C case temperature at the rate of 1 W/°C.
 3. Derate linearly to 150°C free air temperature at the rate of 24 mW/°C.
 4. This rating is based on the capability of the transistor to operate safely in a circuit of: $L = 20 \text{ mH}$, $I_{B(on)} = 0.4 \text{ A}$, $R_{BE} = 100 \Omega$, $V_{BE(off)} = 0$, $R_S = 0.1 \Omega$, $V_{CC} = 20 \text{ V}$.

PRODUCT INFORMATION

electrical characteristics at 25°C case temperature

PARAMETER	TEST CONDITIONS			MIN	TYP	MAX	UNIT
$V_{(BR)CEO}$ Collector-emitter breakdown voltage	$I_C = 30 \text{ mA}$ (see Note 5)	$I_B = 0$	BD249 BD249A BD249B BD249C	45 60 80 100			V
I_{CES} Collector-emitter cut-off current	$V_{CE} = 55 \text{ V}$ $V_{CE} = 70 \text{ V}$ $V_{CE} = 90 \text{ V}$ $V_{CE} = 115 \text{ V}$	$V_{BE} = 0$ $V_{BE} = 0$ $V_{BE} = 0$ $V_{BE} = 0$	BD249 BD249A BD249B BD249C			0.7 0.7 0.7 0.7	mA
I_{CEO} Collector cut-off current	$V_{CE} = 30 \text{ V}$ $V_{CE} = 60 \text{ V}$	$I_B = 0$ $I_B = 0$	BD249/249A BD249B/249C			1 1	mA
I_{EBO} Emitter cut-off current	$V_{EB} = 5 \text{ V}$	$I_C = 0$				1	mA
h_{FE} Forward current transfer ratio	$V_{CE} = 4 \text{ V}$ $V_{CE} = 4 \text{ V}$ $V_{CE} = 4 \text{ V}$	$I_C = 1.5 \text{ A}$ $I_C = 15 \text{ A}$ $I_C = 25 \text{ A}$	(see Notes 5 and 6)	25 10 5			
$V_{CE(sat)}$ Collector-emitter saturation voltage	$I_B = 1.5 \text{ A}$ $I_B = 5 \text{ A}$	$I_C = 15 \text{ A}$ $I_C = 25 \text{ A}$	(see Notes 5 and 6)			1.8 4	V
V_{BE} Base-emitter voltage	$V_{CE} = 4 \text{ V}$ $V_{CE} = 4 \text{ V}$	$I_C = 15 \text{ A}$ $I_C = 25 \text{ A}$	(see Notes 5 and 6)			2 4	V
h_{fe} Small signal forward current transfer ratio	$V_{CE} = 10 \text{ V}$	$I_C = 1 \text{ A}$	$f = 1 \text{ kHz}$	25			
$ h_{fe} $ Small signal forward current transfer ratio	$V_{CE} = 10 \text{ V}$	$I_C = 1 \text{ A}$	$f = 1 \text{ MHz}$	3			

NOTES: 5. These parameters must be measured using pulse techniques, $t_p = 300 \mu\text{s}$, duty cycle $\leq 2\%$.

6. These parameters must be measured using voltage-sensing contacts, separate from the current carrying contacts.

thermal characteristics

PARAMETER	MIN	TYP	MAX	UNIT
$R_{\theta JC}$ Junction to case thermal resistance			1	°C/W
$R_{\theta JA}$ Junction to free air thermal resistance			42	°C/W

resistive-load-switching characteristics at 25°C case temperature

PARAMETER	TEST CONDITIONS †			MIN	TYP	MAX	UNIT
t_{on} Turn-on time	$I_C = 5 \text{ A}$	$I_{B(on)} = 0.5 \text{ A}$	$I_{B(off)} = -0.5 \text{ A}$		0.3		μs
t_{off} Turn-off time	$V_{BE(off)} = -5 \text{ V}$	$R_L = 5 \Omega$	$t_p = 20 \mu\text{s}$, dc $\leq 2\%$		0.9		μs

† Voltage and current values shown are nominal; exact values vary slightly with transistor parameters.

TYPICAL CHARACTERISTICS

TYPICAL DC CURRENT GAIN
VS
COLLECTOR CURRENT

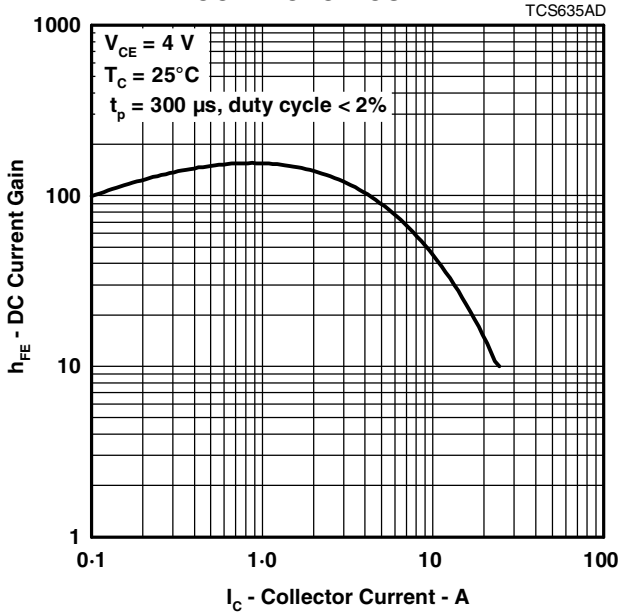

Figure 1.

COLLECTOR-EMITTER SATURATION VOLTAGE
VS
BASE CURRENT

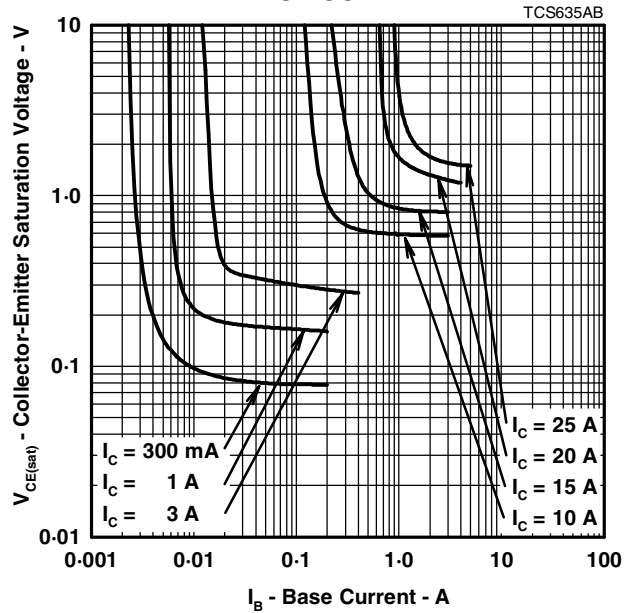

Figure 2.

BASE-EMITTER VOLTAGE
VS
COLLECTOR CURRENT

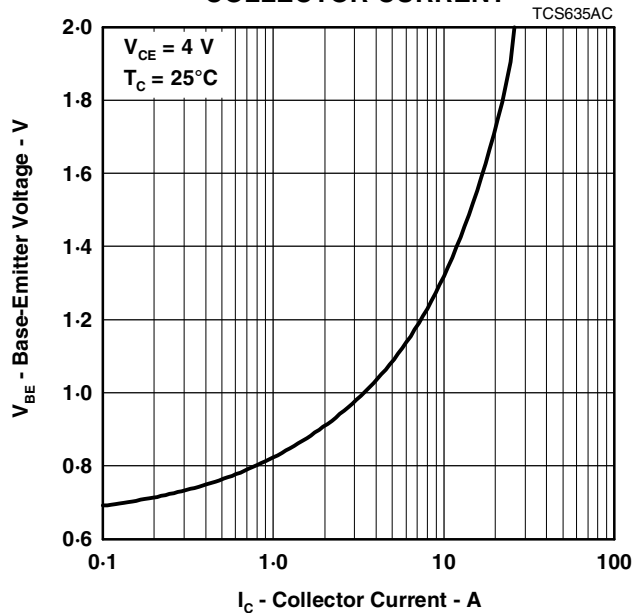
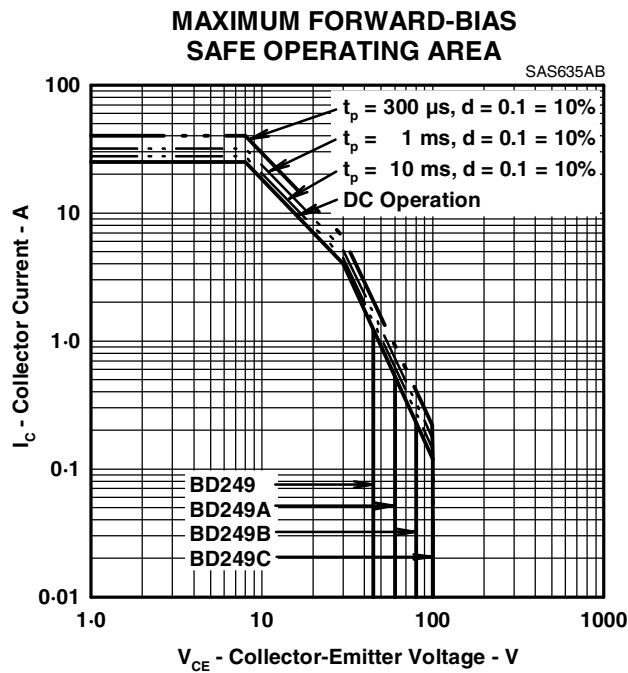

Figure 3.

PRODUCT INFORMATION

MAXIMUM SAFE OPERATING REGIONS



THERMAL INFORMATION

**MAXIMUM POWER DISSIPATION
vs
CASE TEMPERATURE**

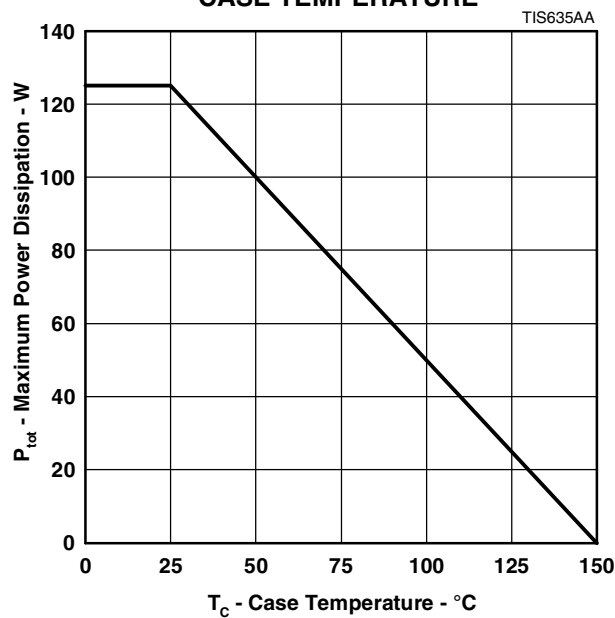

PRODUCT INFORMATION

MECHANICAL DATA

SOT-93

3-pin plastic flange-mount package

This single-in-line package consists of a circuit mounted on a lead frame and encapsulated within a plastic compound. The compound will withstand soldering temperature with no deformation, and circuit performance characteristics will remain stable when operated in high humidity conditions. Leads require no additional cleaning or processing when used in soldered assembly.

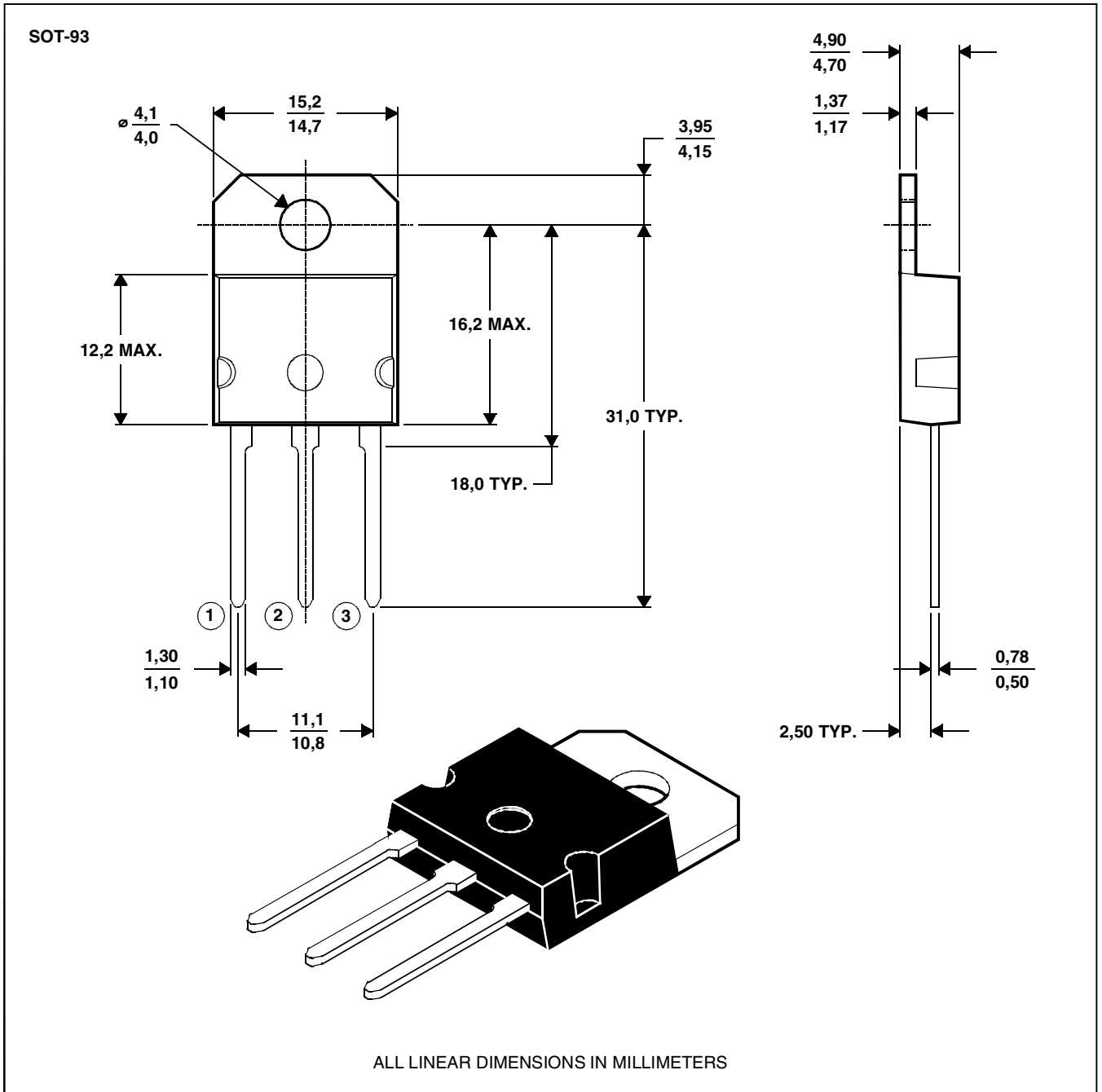

NOTE A: The centre pin is in electrical contact with the mounting tab.

MDXXAW

PRODUCT INFORMATION

JUNE 1973 - REVISED SEPTEMBER 2002
Specifications are subject to change without notice.